

ARCHITECTURAL UNITS: 7-V Fluted Split Face

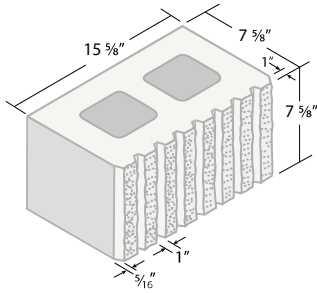

8 x 8 x 16 7V Fluted Split, 1 Face*
ITEM #0887V

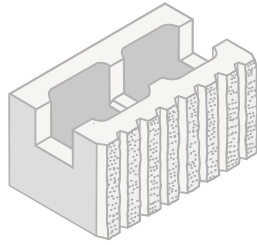

8 x 8 x 16 7V Fluted Split Bond Beam, 1 Face*
ITEM #0887VK

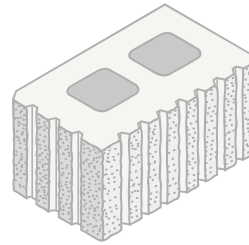

8 x 8 x 16 7V Fluted Split 1 Face / 1 End*
ITEM #0887VFE

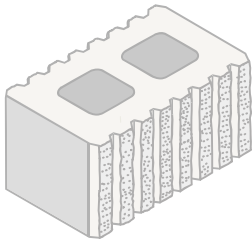

8 x 8 x 16 7V Fluted Split 2 Face**
ITEM #0887VFF

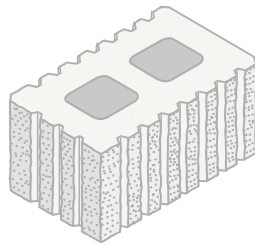

8 x 8 x 16 7V Fluted Split 2 Face/1 End**
ITEM #0887VFFE

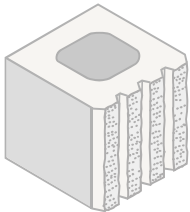

8 x 8 x 8 7V Fluted Split 1 Face Half**
ITEM #0887VH

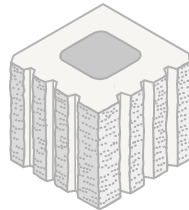

8 x 8 x 8 7V Fluted Split 1 Face / 1 End Half**
ITEM #0887VFEH

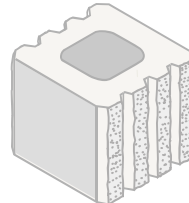

8 x 8 x 8 7V Fluted Split 2 Face Half**
ITEM #0887VFFH

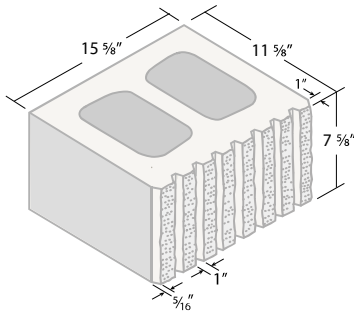

12 x 8 x 16 7V Fluted Split 1 Face**
ITEM #0887V

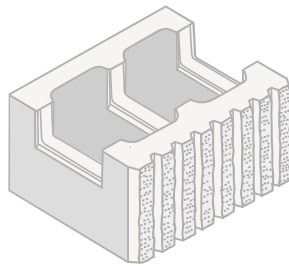

12 x 8 x 16 7V Fluted Split Bond Beam, 1 Face**
ITEM #0887V

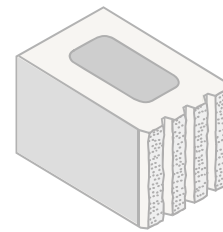

12 x 8 x 8 7V Fluted Split 1 Face Half**
ITEM #0887V